



Cover 1:
Rich Stone

Cover 2:
Marge Grey

Cover 1:
Rich Stone

Cover 2:
Marge Grey

Mid Oak Feet

Portman Collection

Colours represented are to be used as a guide only.
Please refer to manufacturers swatch for a more accurate colour match.

Please note that colour shadings can vary slightly from each roll of fabric.
We cannot guarantee a precise match to these samples or between cut lengths and upholstered goods.

foamflex™

Award Winning Seating Technology

11/10/2021

PORTMAN COVER GUIDE - STANDARD BACK

Please use this guide when ordering the following pieces to clarify cover options.

STANDARD BACK

Corner Group: LH2, R2C

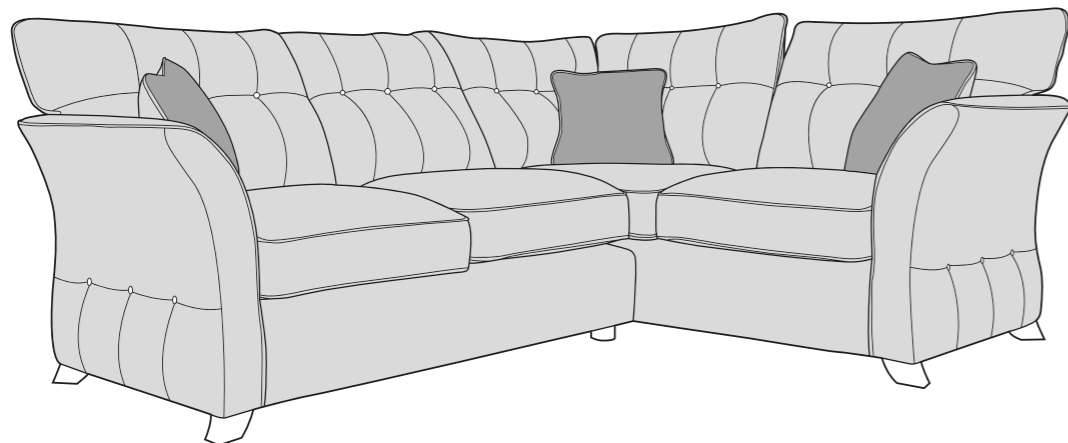

Corner Group: L2C, RH2

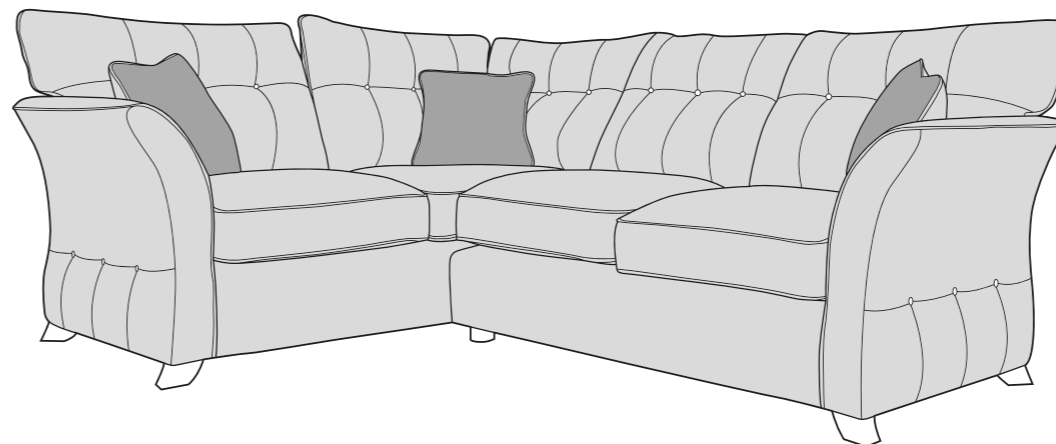

3 Seater sofa (3ST)

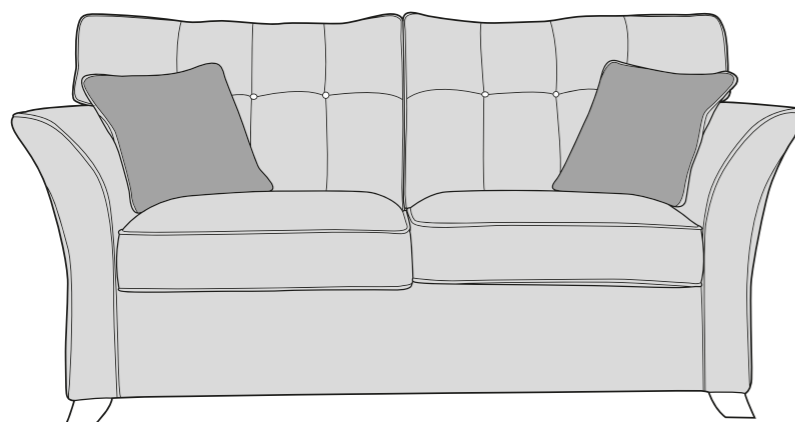

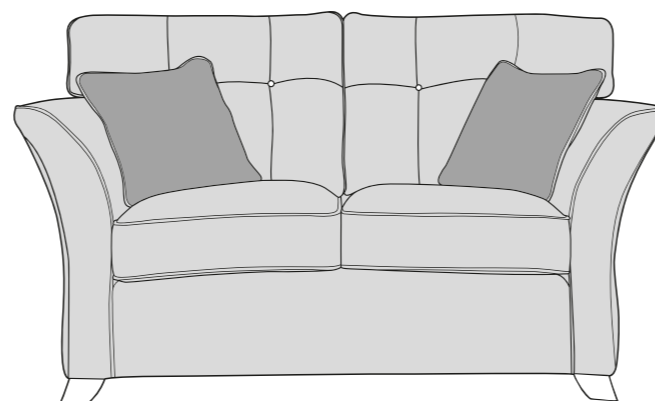

2 Seater sofa (2ST)

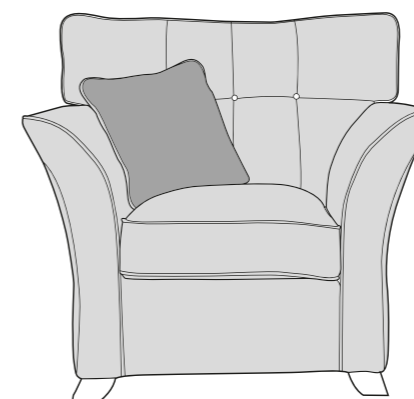

Arm Chair (1ST)



-  **COVER 1**
(BODY)
-  **COVER 2**
(SCATTER)

Scatter Cushions

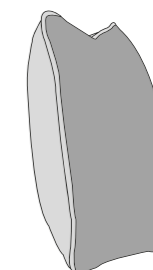

Front = Cover 2
Piping = Cover 1
Reverse = Cover 1

SUGGESTED ACCENT PIECES

York Accent Chair (ACH)

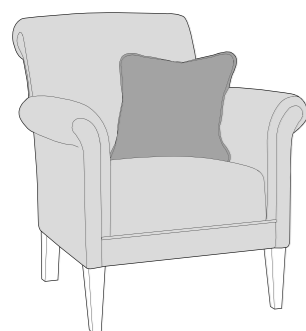

New Fenton
Footstool (FST)

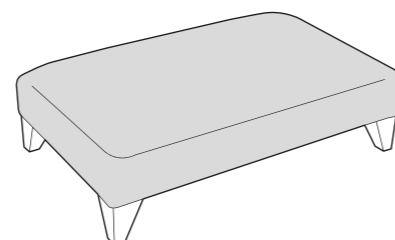

Austin Storage
Footstool (FSS)

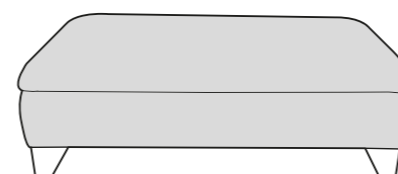

PORTMAN DIMENSIONS (CM)

AVAILABLE PIECES	HEIGHT 1	OUTBACK HEIGHT	WIDTH 2	DEPTH 3	ARM HEIGHT	SEAT HEIGHT 4	SEAT DEPTH (STD) 5	SEAT WIDTH 6	ACCESS DIAGONAL 7	WEIGHT (KG)	SCATTER CUSHIONS
LH2, R2C, FST GROUP or RH2, L2C, FST GROUP	99	71	254	186	73	50	54	N/A	N/A	92	3
LH2/RH2 UNIT	99	71	165	89	73	50	54	142	185	40	1
L2C/R2C UNIT	99	71	186	89	73	50	54	132	202	52	2
3 SEATER SOFA (3ST)	99	71	186	89	73	50	54	139	199	47.5	2
2 SEATER SOFA (2ST)	99	71	162	89	73	50	54	115	180	43	2
ARM CHAIR (1ST)	99	71	105	89	73	50	54	57	129	31.5	1
ACCENT PIECES											
YORK ACCENT CHAIR (ACH)	85	N/A	76	81		45	50	48	N/A	19.5	1
NEW FENTON FOOTSTOOL (FST)	35	N/A	106	65	N/A	N/A	N/A	N/A	75	14.5	N/A
STORAGE FOOTSTOOL (FSS)	37	N/A	104	64	N/A	N/A	N/A	N/A	117	21.5	N/A



* Mid Oak & Antique foot options.

* Hardwood & composite board frame.

* Dowelled, screwed, glued & stapled joinery.

* Award winning foamflex seat interior with 5 year guarantee.

* Fibre Filled backs for added comfort.

* Serpentine seat springs and silent wire.

* Elasticated back webbing.

DIMENSION GUIDE

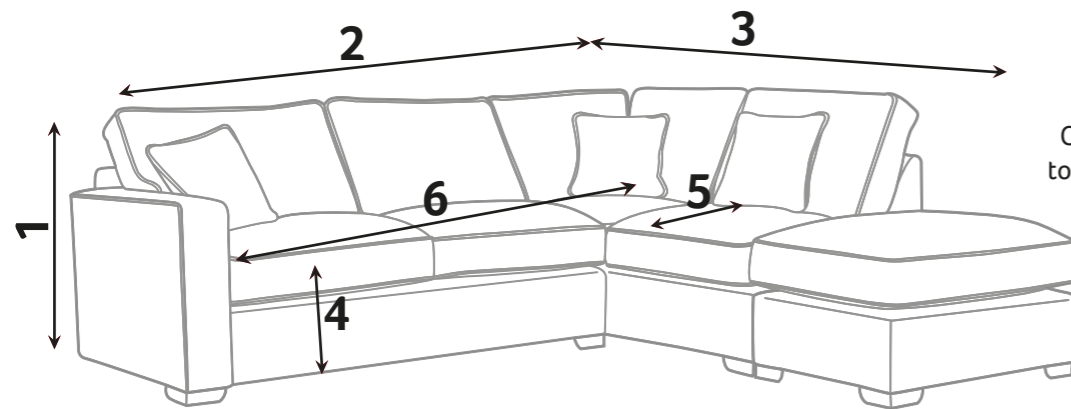

Check the diagonal access dimension to ensure furniture will fit in your home.

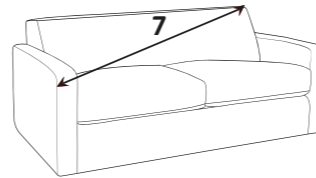

1 - HEIGHT
2 - WIDTH

3 - DEPTH
4 - SEAT HEIGHT

5 - SEAT DEPTH (STD & PILLOW)
6 - SEAT WIDTH

7 - DIAGONAL ACCESS

Illustrations used for reference only.

Please note : All dimensions are approximate. Allow tolerance of +/- 2.5cm.

foamflex™

Our new, expertly engineered foam seat interior gives you the comfort of fibre with the retention of foam. Our foamflex seat interiors have been granted the FIRA GOLD Award, a mark of quality under-pinning all necessary testing of the product materials, design and production techniques.

CARE GUIDE

To improve the longevity of your hand-made furniture, we recommend rotating cushions (where applicable).

For further information on maintaining your furniture, please refer to the Care Guide located under the seat platform.



Our foamflex seat interiors have been granted the FIRA GOLD Award, a mark of quality under-pinning all necessary testing of the product materials, design and production techniques.

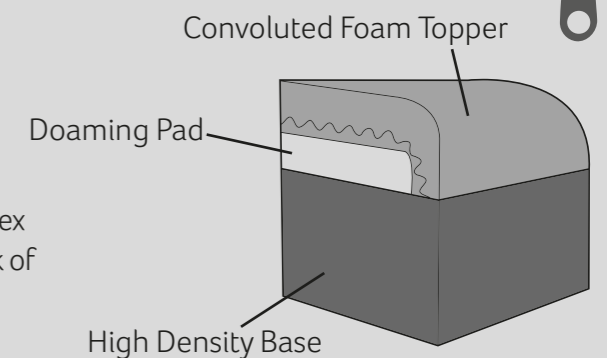

Mid Oak (light)

Antique (dark)



FOOT OPTIONS:

Wood is a natural product and will vary in shade/colour from item to item. Feet may require fitting.

